

TEMPER

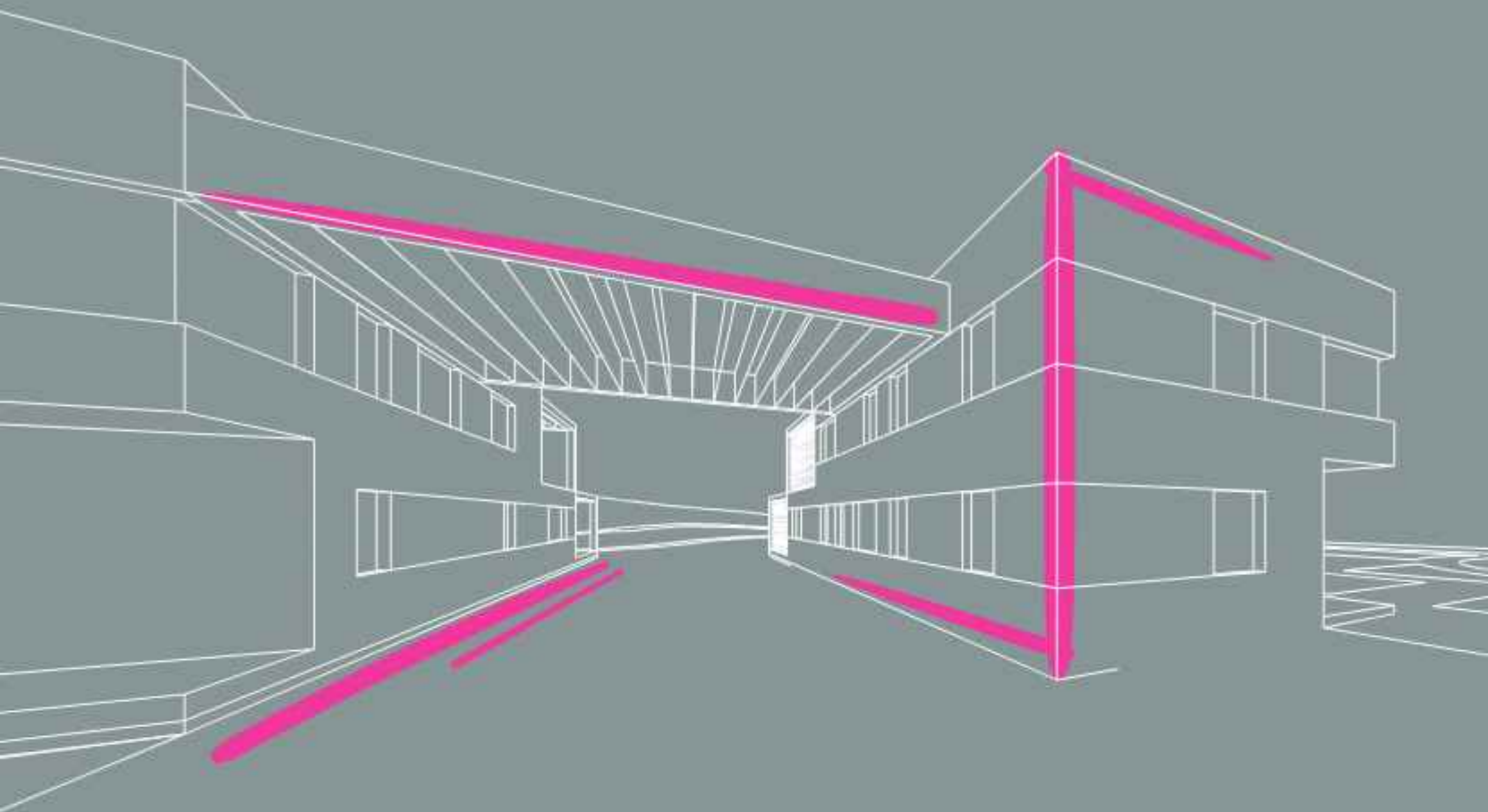

TEMPRARE

/tem·prà·re/

verbo transitivo

1. Sottoporre un metallo al trattamento di tempra per aumentarne la durezza e la resistenza meccanica
2. Fortificare il fisico, il carattere e lo spirito di una persona

temper

/tem·per/

transitive verb

1. To subject a metal to tempering treatment in order to increase its hardness and mechanical strength
2. To strengthen the body, character and spirit of a person

tremper

/trã·pe/

verbe transitif

1. Pratiquer l'opération de trempo d'un métal pour en augmenter la dureté et la résistance mécanique
2. Fortifier le physique, le caractère et l'esprit d'une personne

härten

/här|ten/

Transitives Verb

1. Ein Metall einem Härungsverfahren unterziehen, um seine Festigkeit und mechanische Widerstandsfähigkeit zu erhöhen
2. Den Körper, Charakter und Geist einer Person stärken

закалять

/за·ка·лять/

переходный глагол

1. Подвергать металл процессу закалки для повышения его твердости и механической прочности
2. Укреплять тело, характер и дух человека

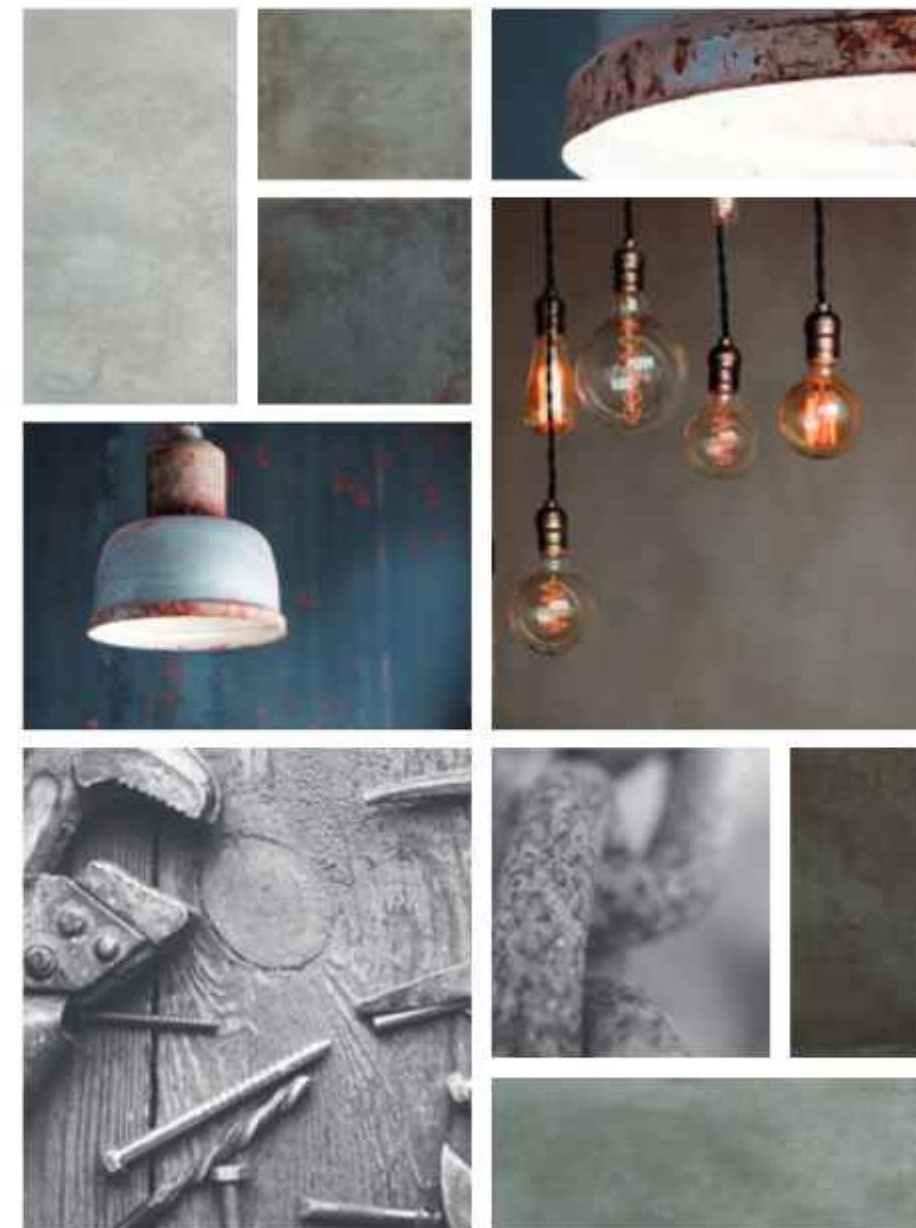

TEMPER GOLDEN

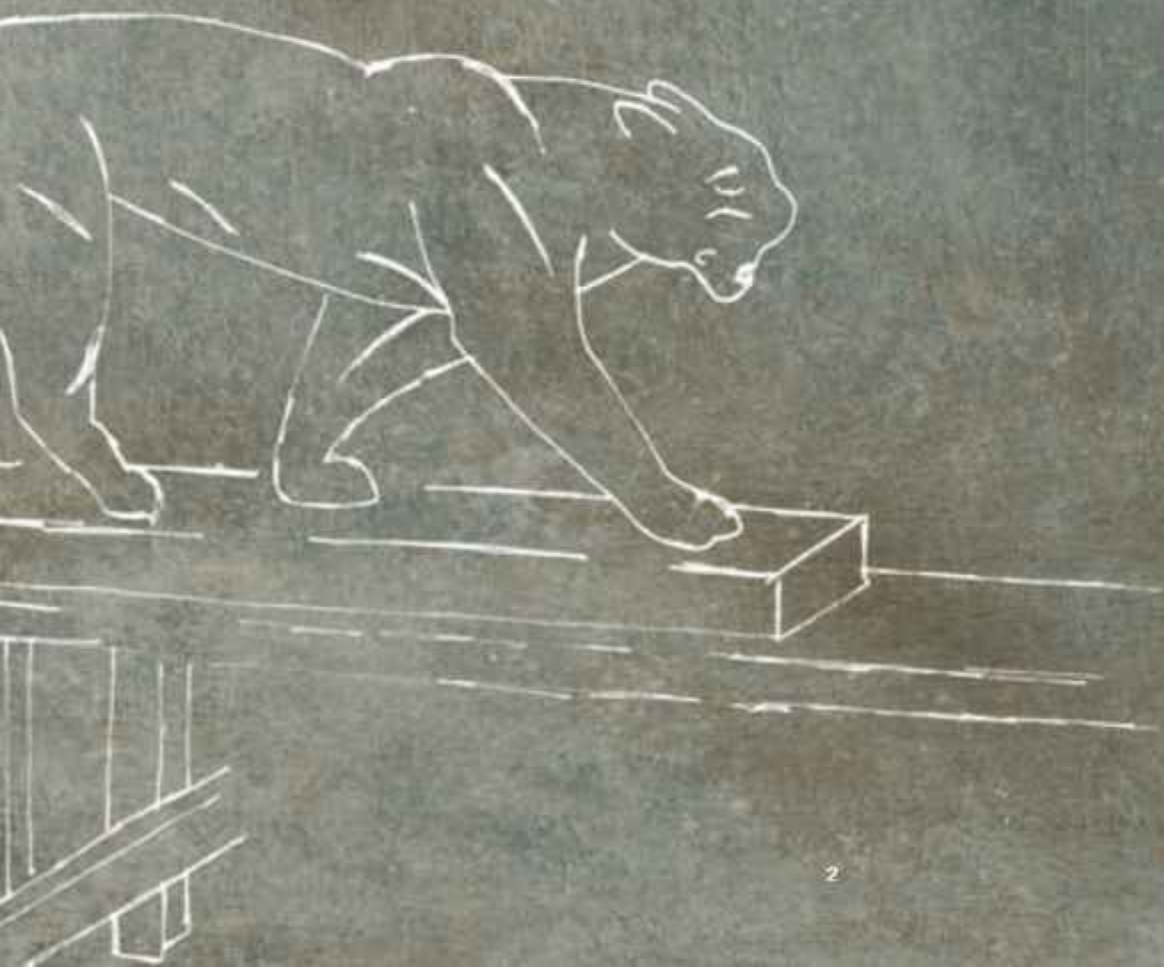

TEMPER GOLDEN
50x100 . 20"x40" BETT

TEMPER GOLDEN
50x100 - 20"x40" RETT



TEMPER GOLDEN
50x100 - 20"x40" RETT

TEMPER GOLDEN
50x100 - 20"x40" RETT



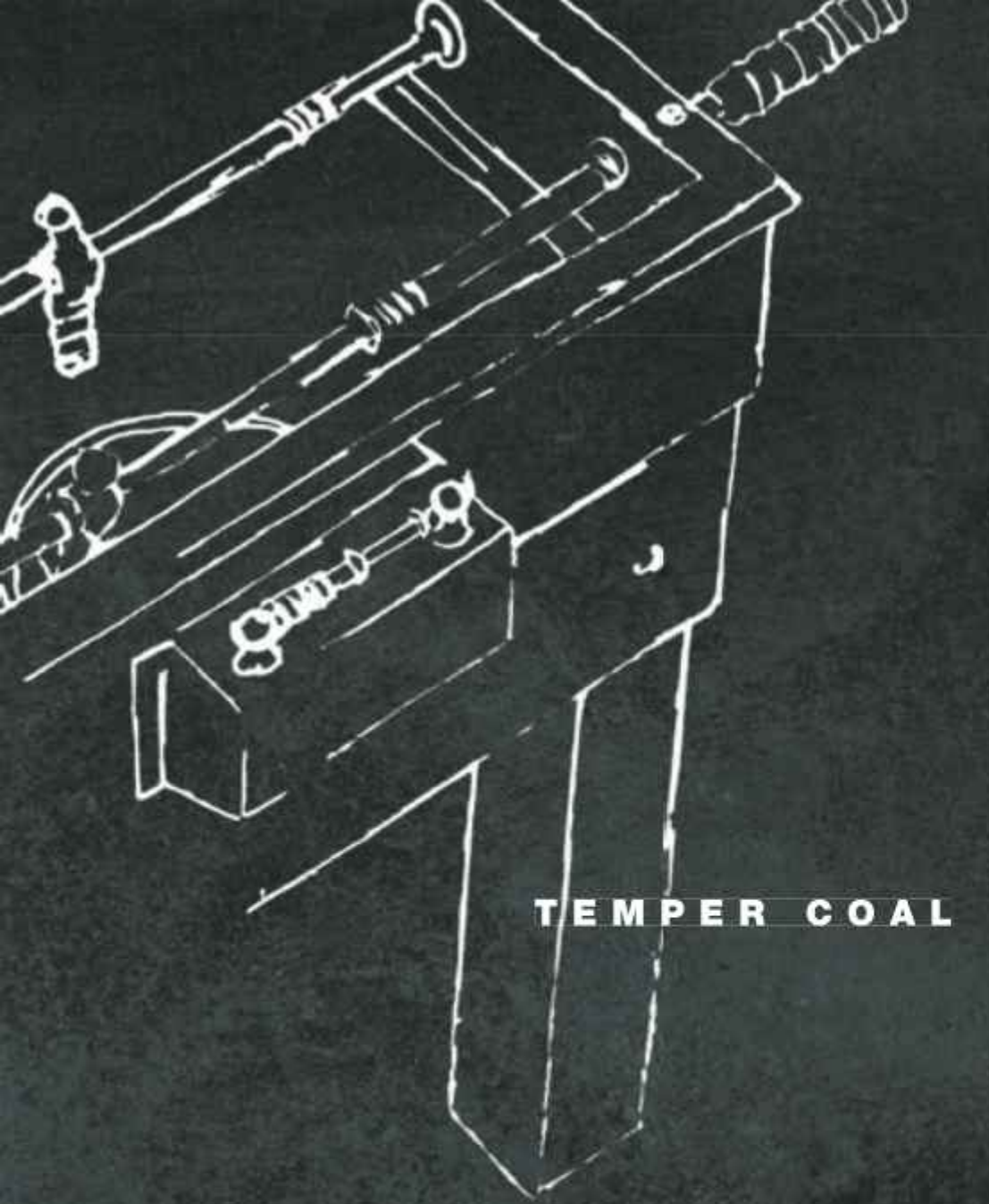

TEMPER COAL



TEMPER COAL
100x100 - 40x40 FETT



TEMPER COAL
100x100 - 40"x40" RETT

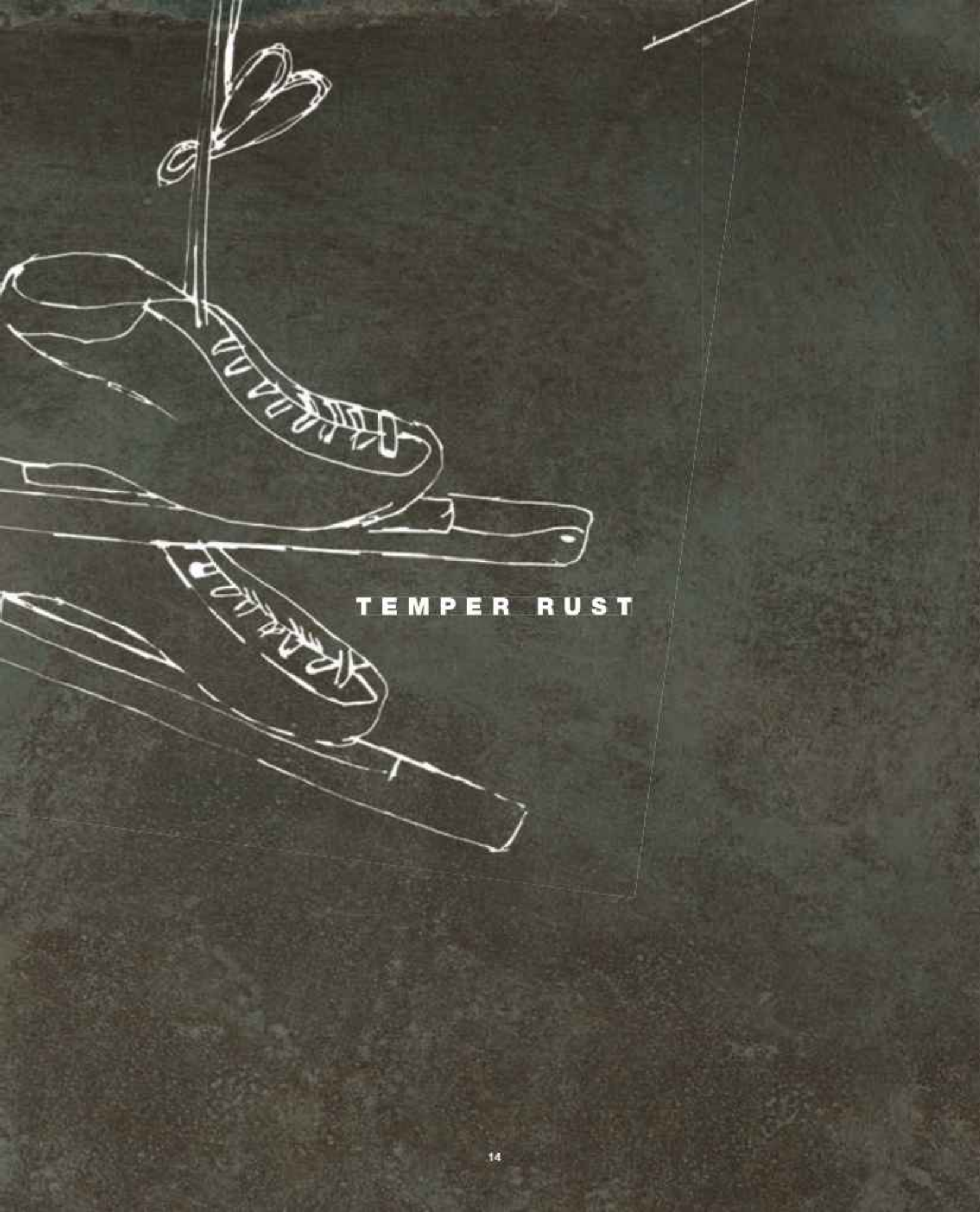

TEMPER RUST
60x120 . 24"x48" RETT
30x120 . 12"x48" SCRATCH RETT

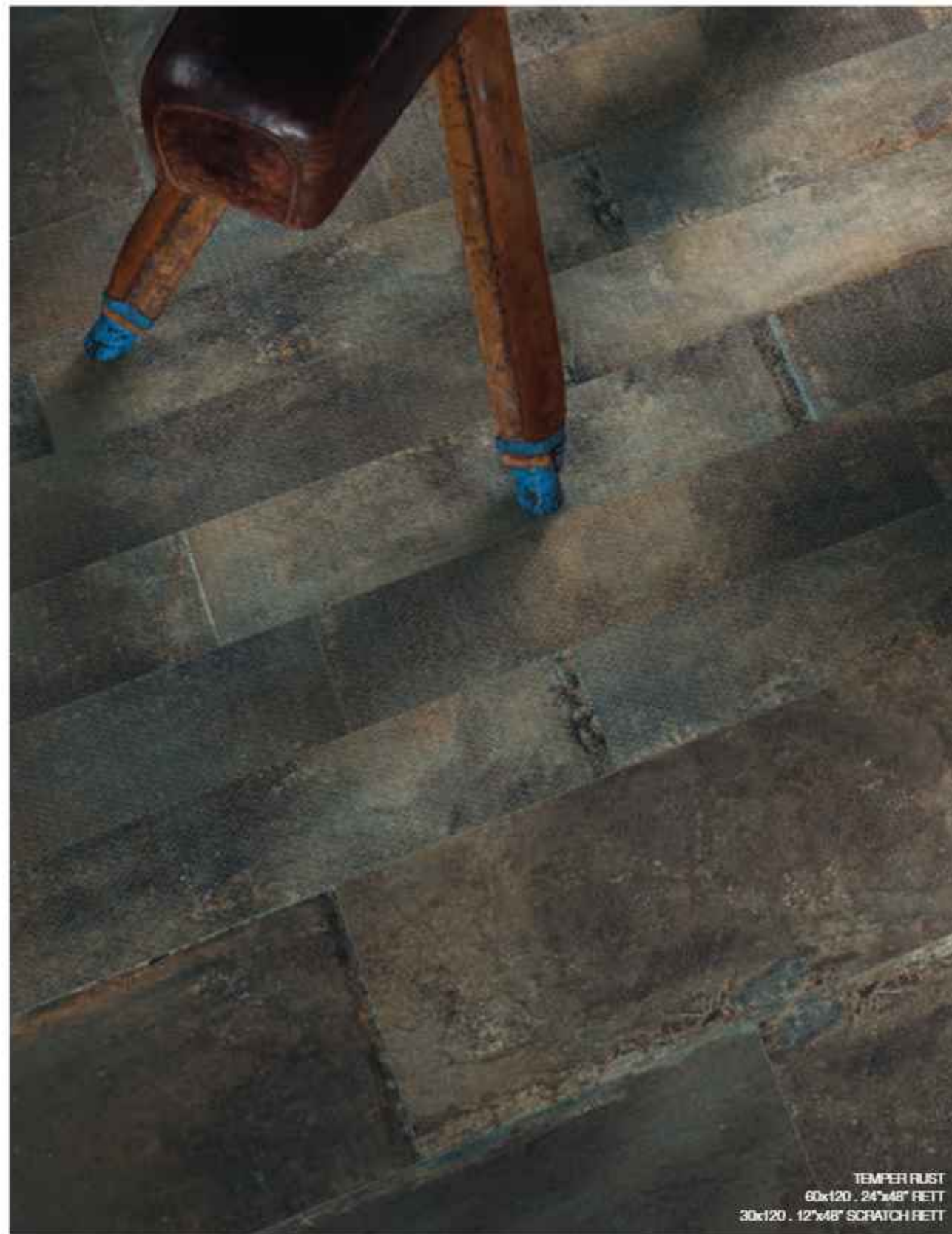

TEMPER RUST
60x120 . 24"x48" RETT
30x120 . 12"x48" SCRATCH RETT

TEMPER FLUST
60x120 . 24"x48" RETT
30x120 . 12"x48" SCRATCH RETT



TEMPER FLIST
60x120 20x48 11FT
30x120 12x48 60x110 11FT



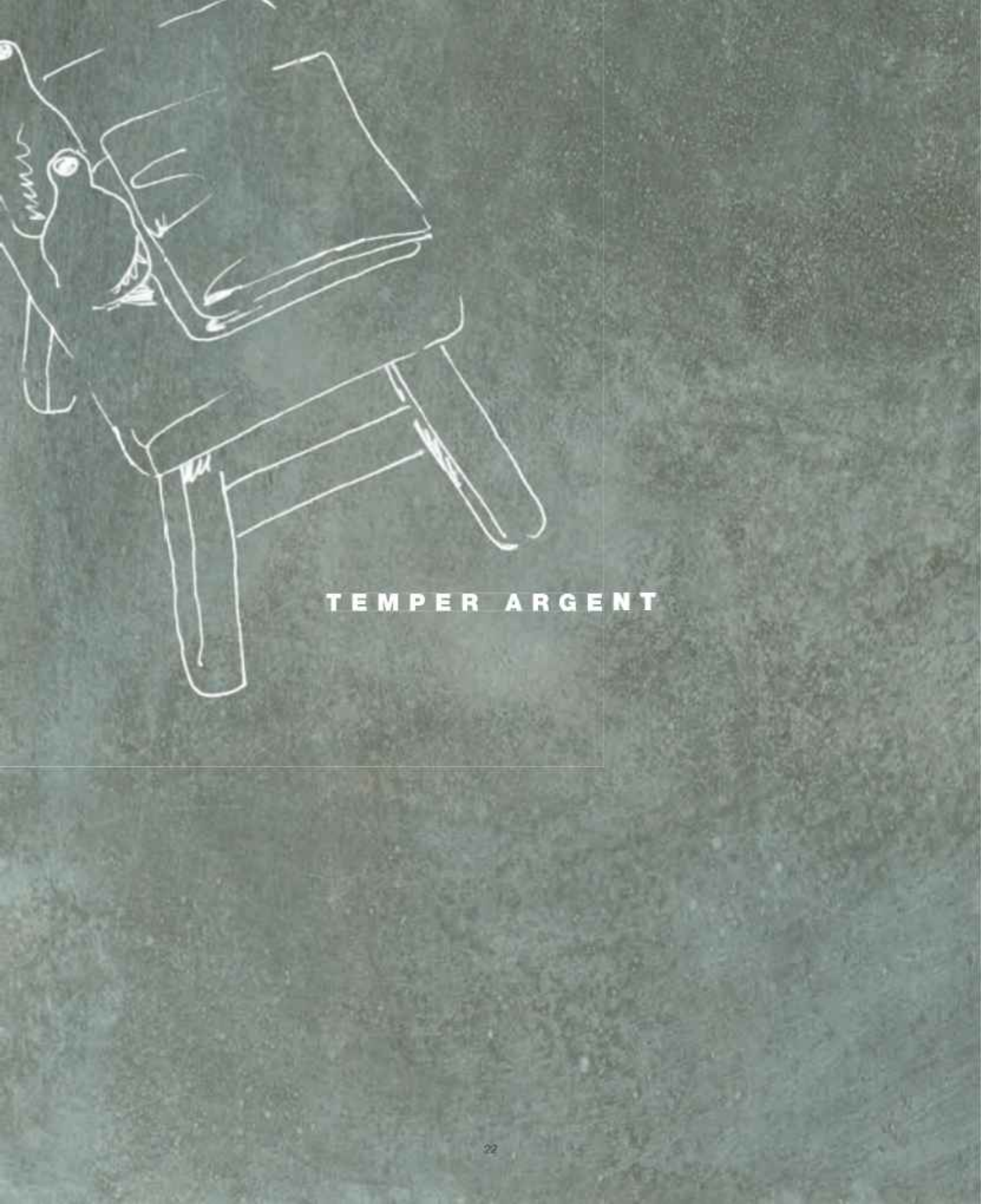

TEMPER ARGENT



TEMPER ARGENT
100x100 . 40"x40" FETT
Mosaico Brick Mix 24x40 . 9 7/16"x16" FETT

TEMPER ARGENT
120x120 . 48"x48" RETT - 60x120 . 24"x48" RETT
Bamboo Silver (base Argent) comp 2 pz 120x120 . 48"x48" RETT



TEMPER ARGENT
120x120 - 48"x48" FETT
Mosaico Bisca Mx.24x40 - 0 7/8"x16" FETT



TEMPER ARGENT
80x180 . 32"x72" RETT
Bamboo Silver (base Argent) comp 2 pz 120x120 . 46"x46" RETT



TEMPER ARGENT
M. 100x100 (P. 100x100) . 39 1/2"x39 1/2" RETT

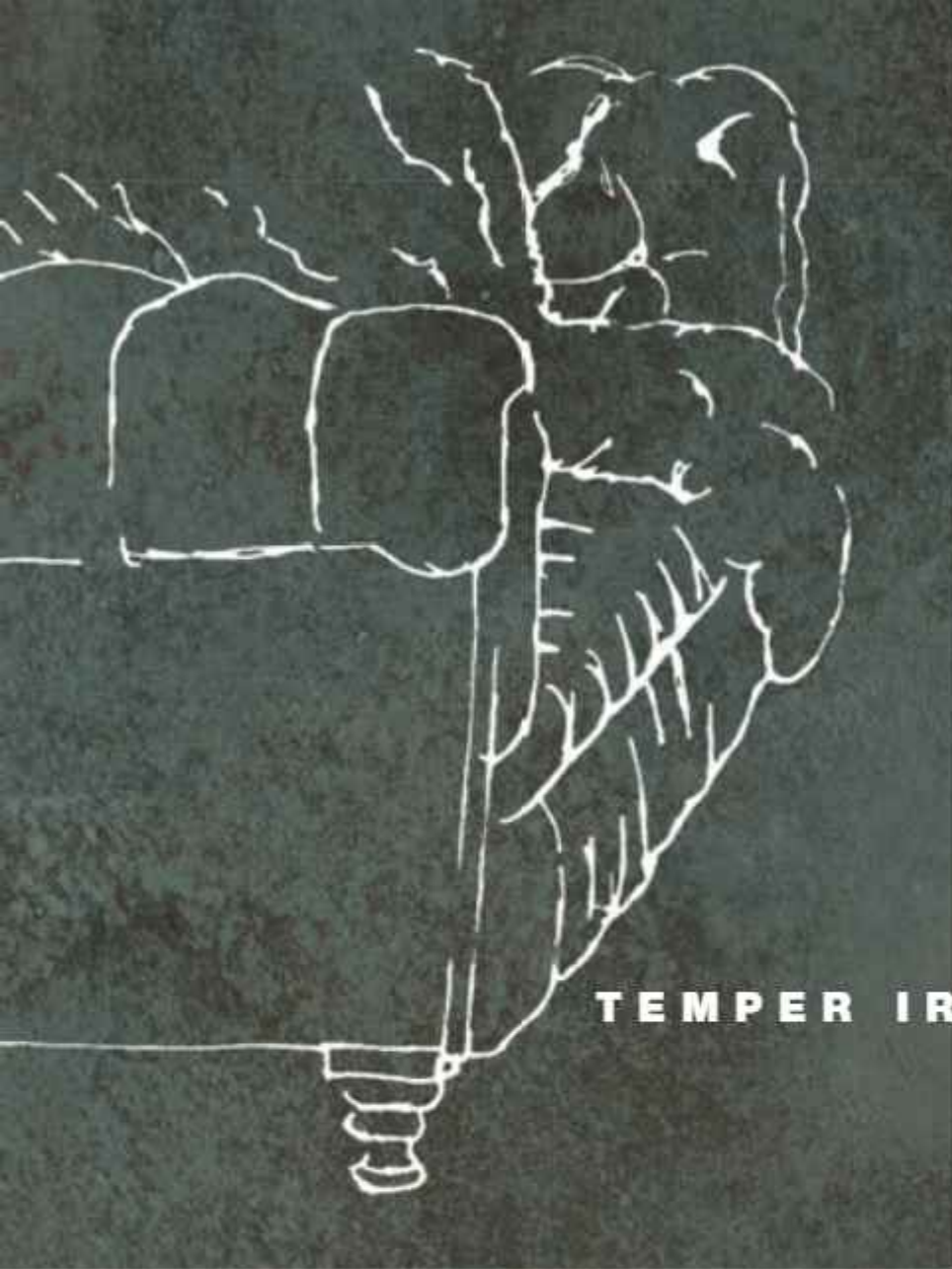

TEMPER IRON



TEMPER IRON
80x180 . 32"x72" FETT

TEMPER IRON
80x180 . 32"x72" FETT



TEMPER IRON
80x180 . 32"x72" FETT

TEMPER IRON
60x60 . 24"x24" FETT
Inserto Weld Silver S/5 30x30 . 12"x12" FETT



TEMPER IRON
100x100 . 40"x40" SCRATCH FETT

TEMPER FROST

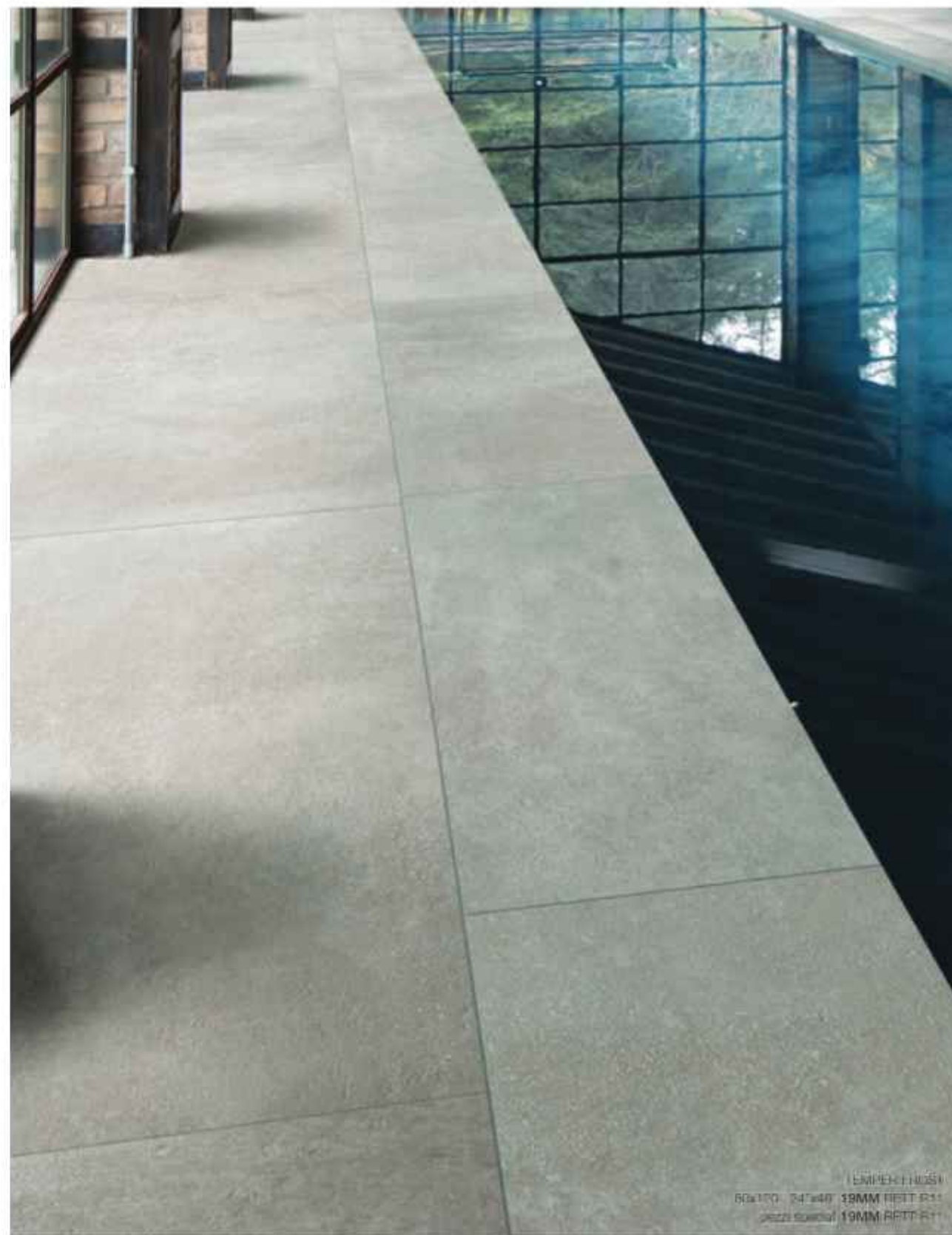
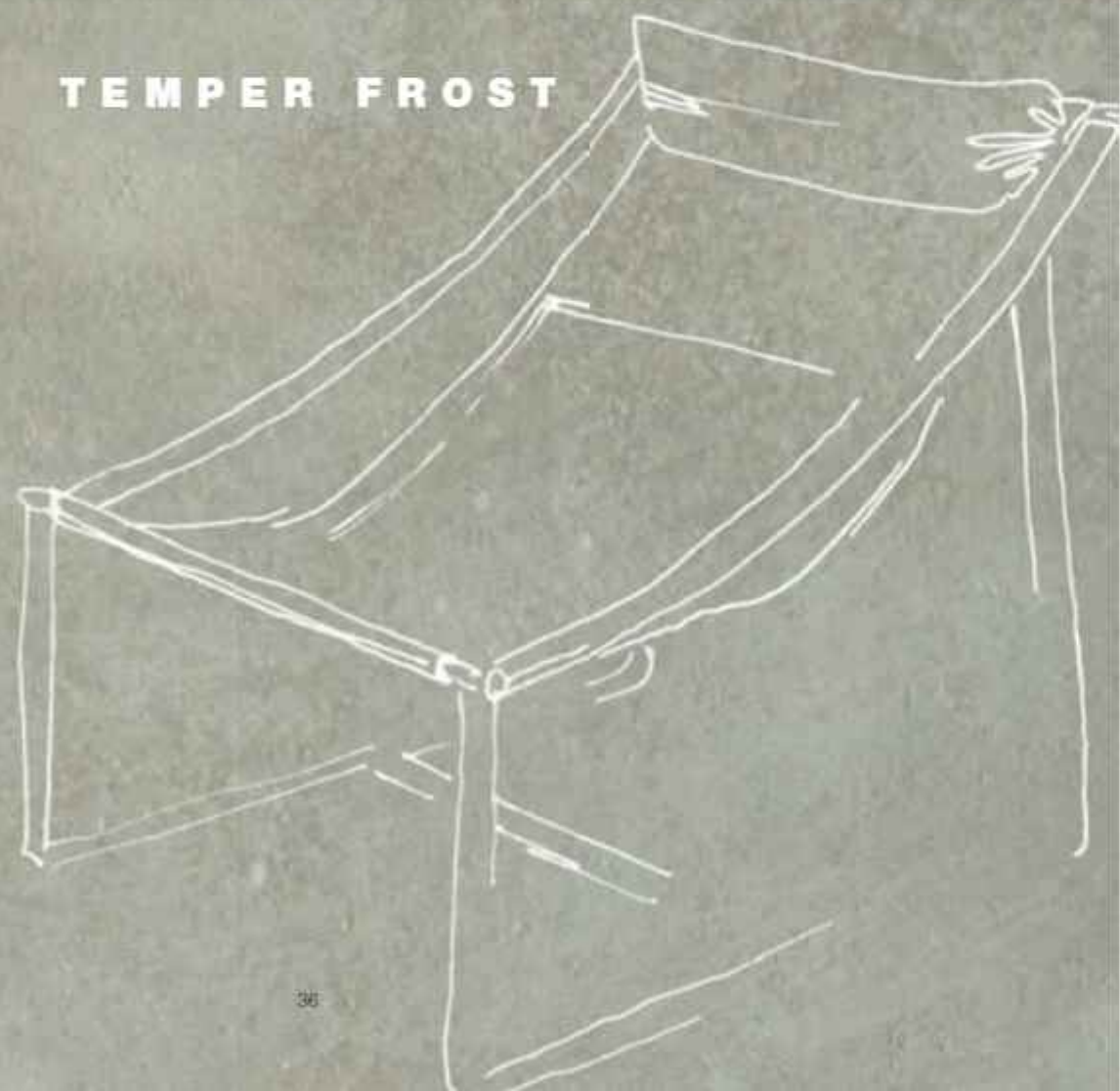

TEMPER FROST
60x120 - 74x40 19MM RPTT R11
60x120 - 74x40 19MM RPTT R11

TEMPER FROST
60x120 . 24"x48" 19MM RETT R11
pezzi speciali 19MM RETT R11



TEMPER FROST
60x120 . 24"x48" 19MM RETT R11
pezzi speciali 19MM RETT R11

TEMPER FROST
120x120 . 48"x48" FRET
Mosaico Metallic 30x30 . 12"x12" FRET



TEMPER FROST
60x120 . 24"x48" 19MM FETT R11



TEMPER FROST
60x120 . 24"x48" 19MM FETT R11

TEMPER

80x180 - 32"x72" . 120x120 - 48"x48" . 60x120 - 24"x48" . 30x120 - 12"x48" . 60x60 - 24"x24" . 30x60 - 12"x24" . 100x100 - 40"x40" . 50x100 - 20"x40"

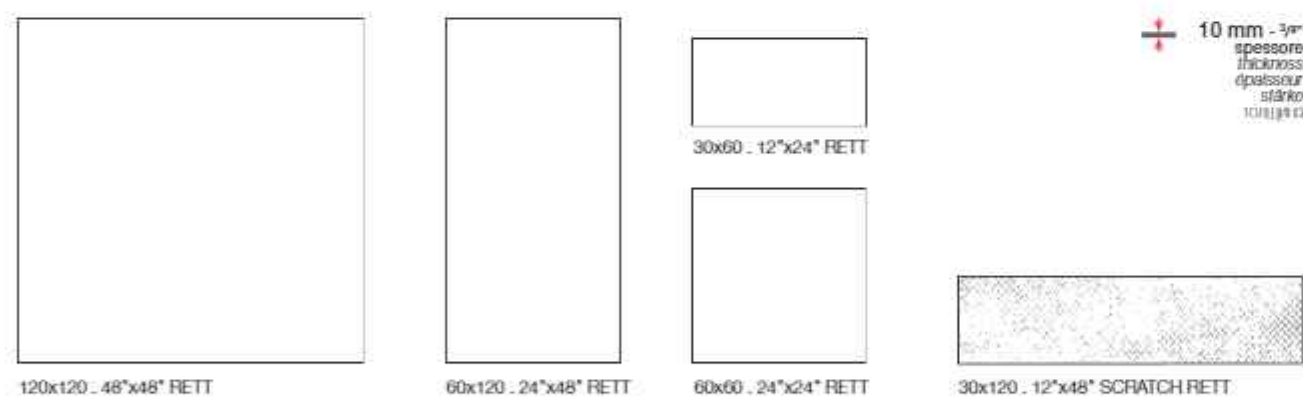
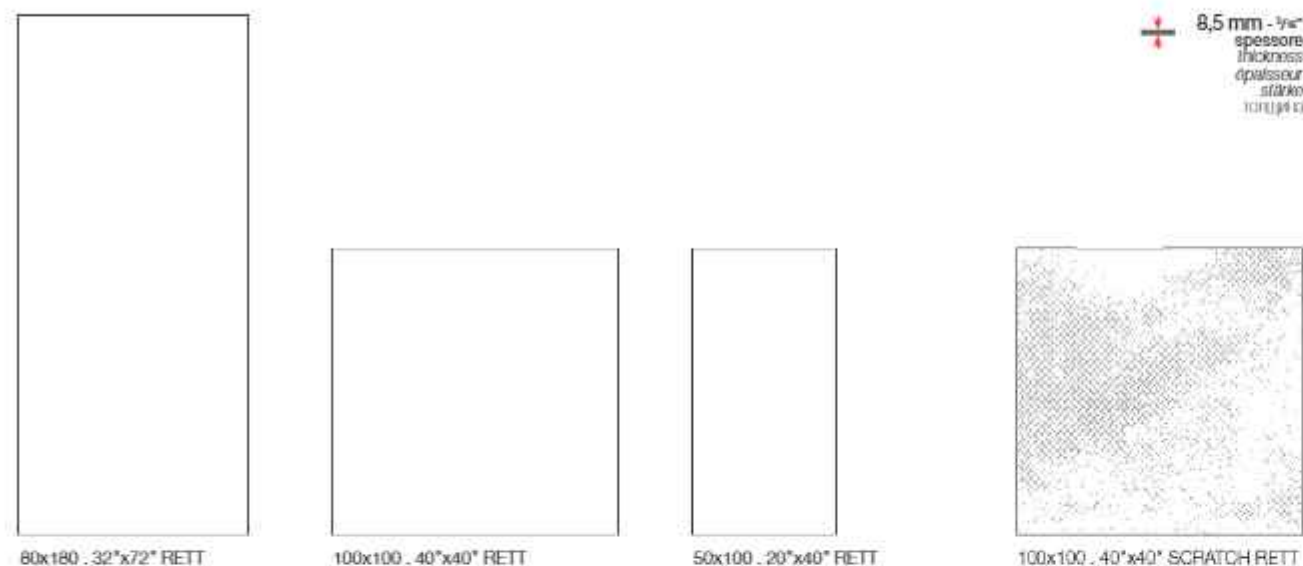

Colors: Temper Frost . Temper Golden . Temper Iron . Temper Flust

GRES PORCELLANATO SMALTATO COLORATO IN MASSA
GLAZED PORCELAIN STONEWARE WITH COLOURED BODY / GRES CÉRAMI ÉMAILLÉ COLORÉ DANS LA MASSE
GLAZIERTES FEINSTEINHAUTIG IN DER MASSE GUTÄRTE / ЦВЯТКОПОВА ГЛАЗУР КЪС ПАНЦИ ВЪВ ВИТ, ОКРАВЕНО ВЪВ ТЕЛОТО



Pezzi Speciali . Trims . Pièces Spéciales . Formstücke . Специални елементи

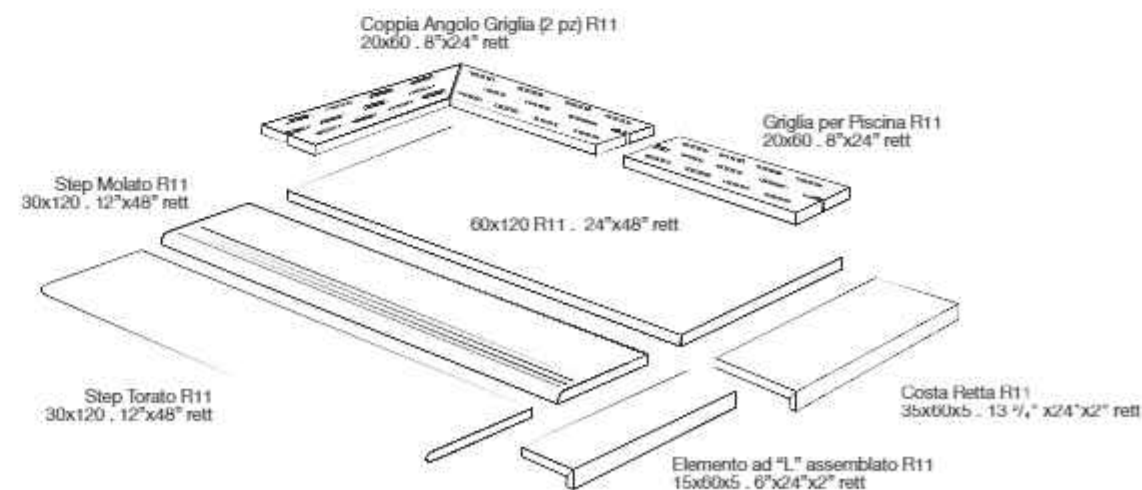
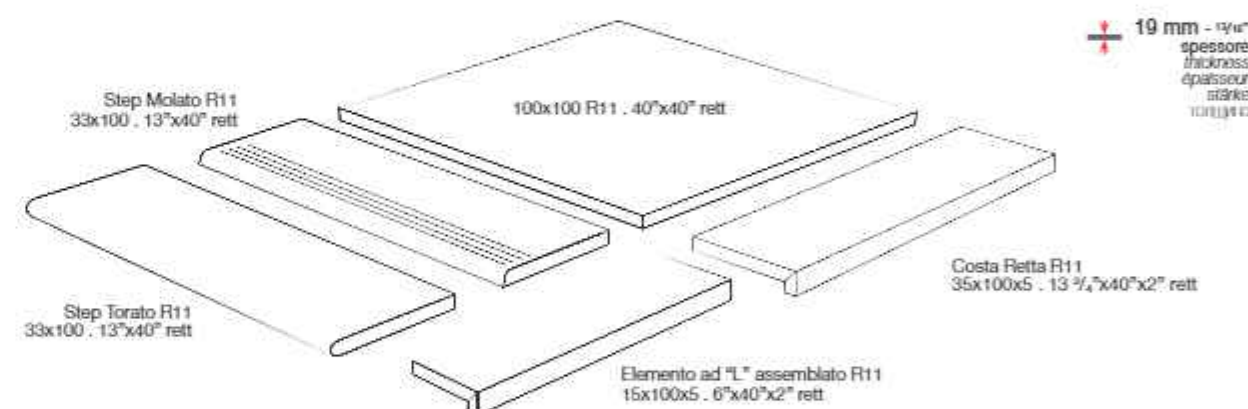

TEMPER GOLDEN

80x180 - 32"x72" . 120x120 - 48"x48" . 60x120 - 24"x48" . 30x120 - 12"x48" . 60x60 - 24"x24" . 30x60 - 12"x24" . 100x100 - 40"x40" . 50x100 - 20"x40"



TEMPER COAL

80x180 - 32"x72" . 120x120 - 48"x48" . 60x120 - 24"x48" . 30x120 - 12"x48" . 60x60 - 24"x24" . 30x60 - 12"x24" . 100x100 - 40"x40" . 50x100 - 20"x40"



TEMPER RUST

80x180 - 32"x72" . 120x120 - 48"x48" . 60x120 - 24"x48" . 30x120 - 12"x48" . 60x60 - 24"x24" . 30x60 - 12"x24" . 100x100 - 40"x40" . 50x100 - 20"x40"



TEMPER ARGENT

80x180 - 32"x72" . 120x120 - 48"x48" . 60x120 - 24"x48" . 30x120 - 12"x48" . 60x60 - 24"x24" . 30x60 - 12"x24" . 100x100 - 40"x40" . 50x100 - 20"x40"



TEMPER FROST

80x180 - 32"x72" . 120x120 - 48"x48" . 60x120 - 24"x48" . 30x120 - 12"x48" . 60x60 - 24"x24" . 30x60 - 12"x24" . 100x100 - 40"x40" . 50x100 - 20"x40"



TEMPER IRON

80x180 - 32"x72" . 120x120 - 48"x48" . 60x120 - 24"x48" . 30x120 - 12"x48" . 60x60 - 24"x24" . 30x60 - 12"x24" . 100x100 - 40"x40" . 50x100 - 20"x40"

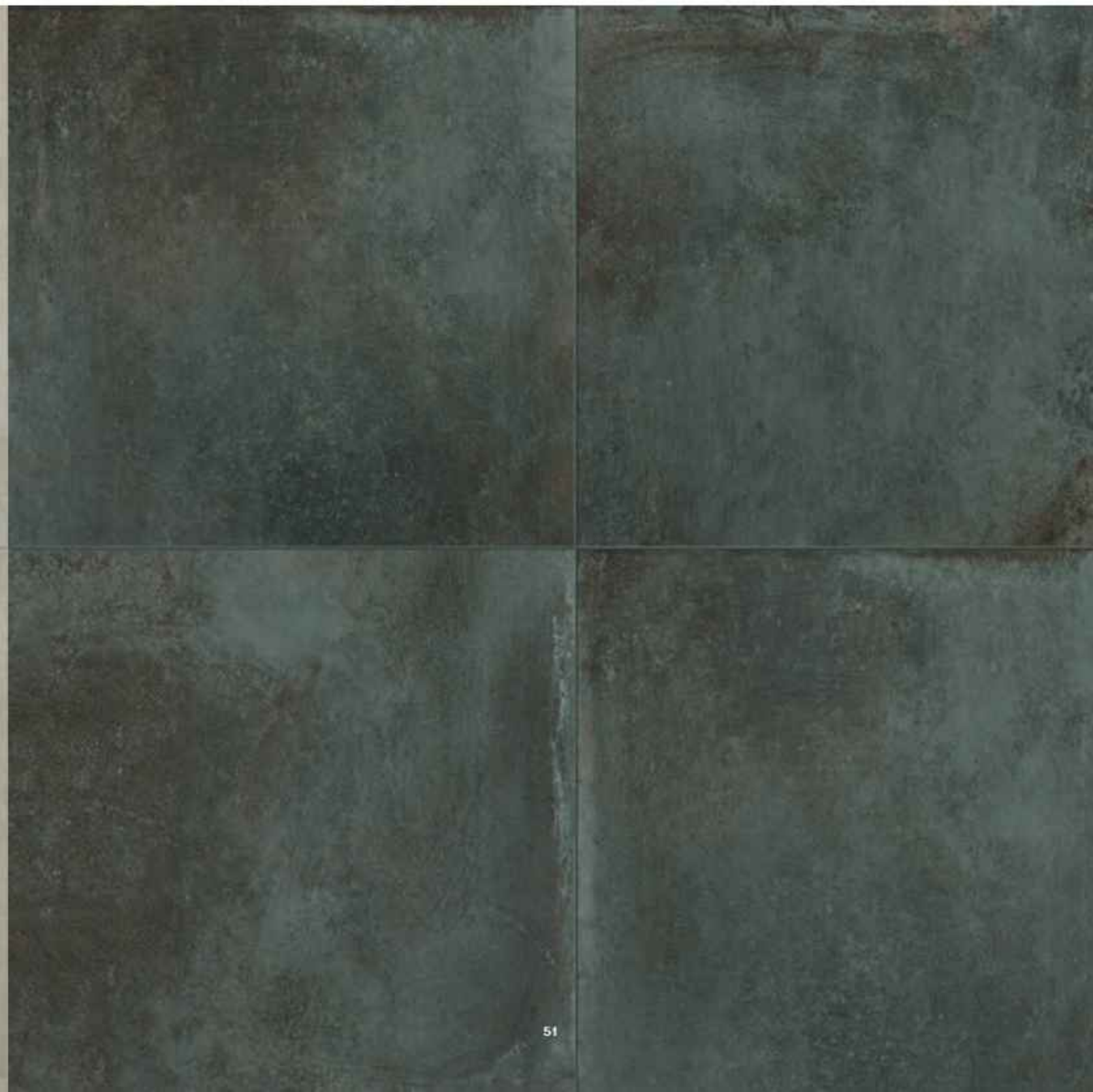

TEMPER

Mosaici . Mosaics . Mosaïques . Mosaiken . Mosaicos

TEMPER FROST



MOSAICO INTRECCIO
30x30 - 12"x12" RETT



MOSAICO METALLIC
30x30 - 12"x12" RETT



MOSAICO BRICKS MIX
24x40 - 9 7/16"x16" RETT

TEMPER IRON

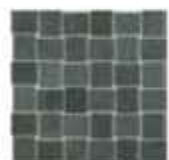

MOSAICO INTRECCIO
30x30 - 12"x12" RETT



MOSAICO METALLIC
30x30 - 12"x12" RETT



MOSAICO BRICKS MIX
24x40 - 9 7/16"x16" RETT

TEMPER GOLDEN



MOSAICO INTRECCIO
30x30 - 12"x12" RETT



MOSAICO METALLIC
30x30 - 12"x12" RETT



MOSAICO BRICKS MIX
24x40 - 9 7/16"x16" RETT

TEMPER ARGENT

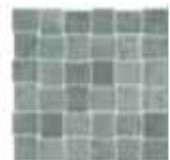

MOSAICO INTRECCIO
30x30 - 12"x12" RETT



MOSAICO METALLIC
30x30 - 12"x12" RETT



MOSAICO BRICKS MIX
24x40 - 9 7/16"x16" RETT

TEMPER COAL



MOSAICO INTRECCIO
30x30 - 12"x12" RETT



MOSAICO METALLIC
30x30 - 12"x12" RETT



MOSAICO BRICKS MIX
24x40 - 9 7/16"x16" RETT

TEMPER RUST



MOSAICO INTRECCIO
30x30 - 12"x12" RETT



MOSAICO METALLIC
30x30 - 12"x12" RETT



MOSAICO BRICKS MIX
24x40 - 9 7/16"x16" RETT

10 mm - 3/8"
spessore
thickness
épaisseur
stärke
IC111 (P11)



TEMPER ARGENT
60x120 - 24"x48" RETT
Mosaico Intreccio 30x30 - 12"x12" RETT

TEMPER

Decori . Decors . Décors . Dekore . Декоры

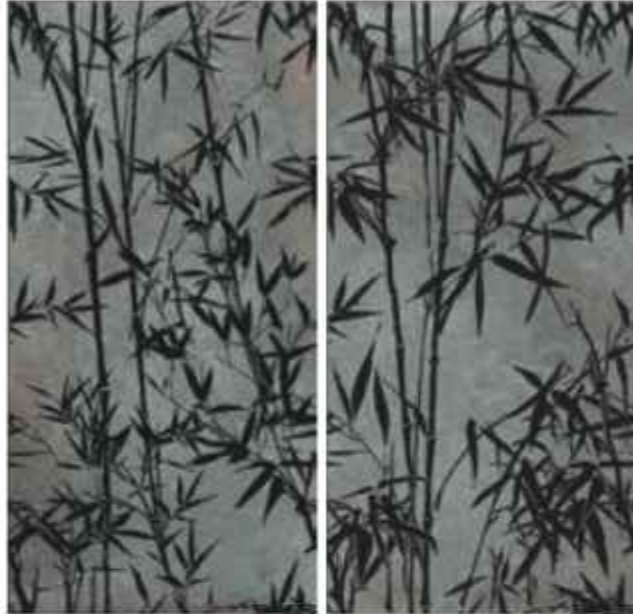

BAMBOO SILVER (base Argent) comp 2 pz.
120x120 - 48"x48" RETT



BAMBOO BRONZE (base Golden) comp 2 pz.
120x120 - 48"x48" RETT

10 mm - 3/8"
spessore
thickness
épaisseur
stärke
ГОЛУБИЦА

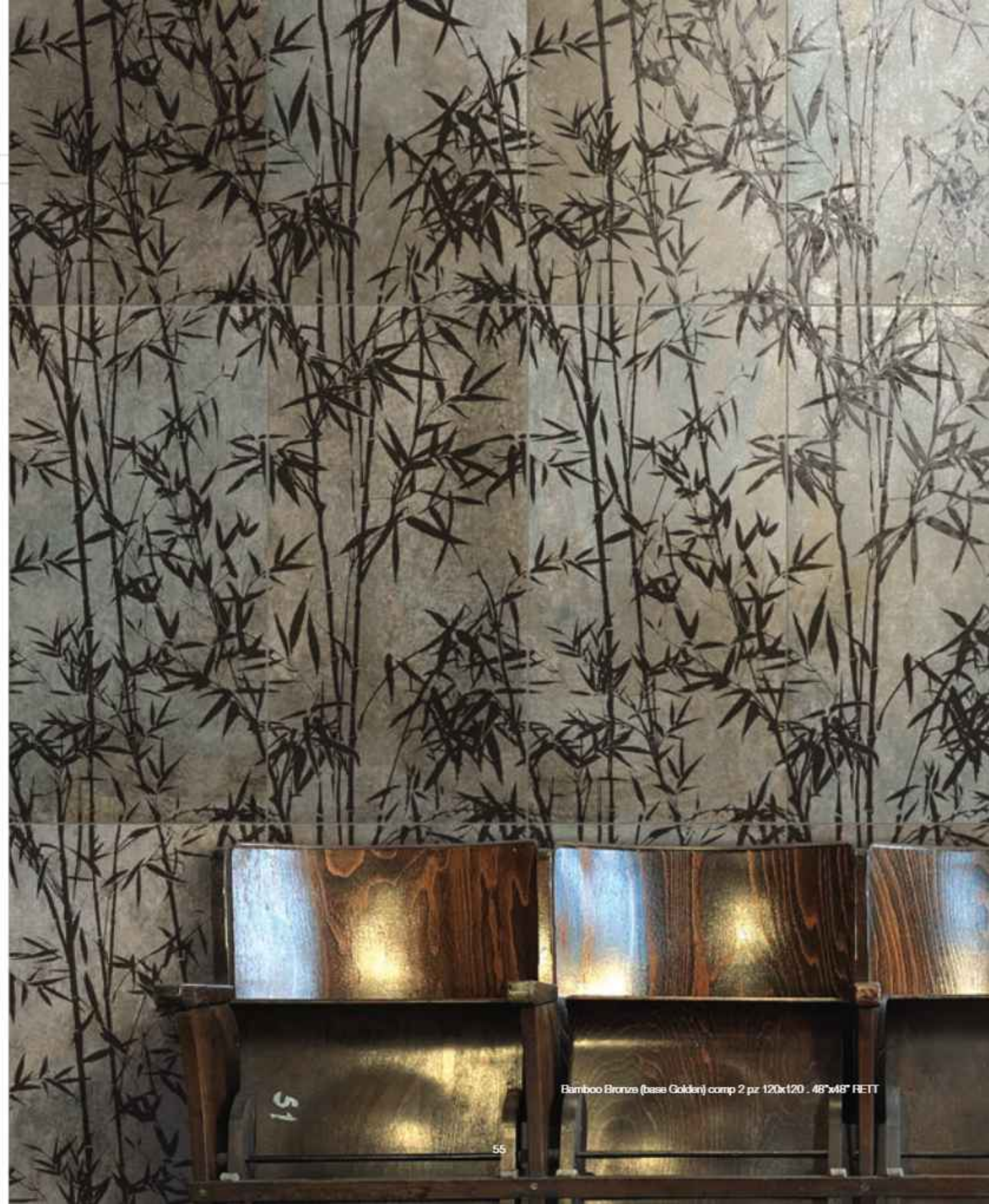

Bamboo Bronze (base Golden) comp 2 pz 120x120 - 48"x48" RETT

TEMPER

Decorì . Decors . Décors . Dekore . Декоры

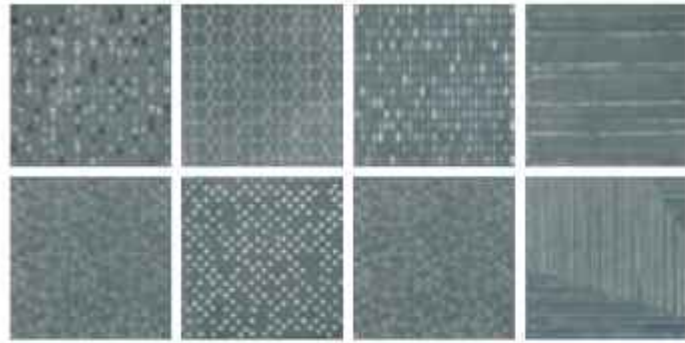

INSERTO WELD SILVER S/8
30x30 - 12"x12" RETT



INSERTO WELD BRONZE S/8
30x30 - 12"x12" RETT

✚ 10 mm - 3/8"
spessore
thickness
épaisseur
stárka
толщина

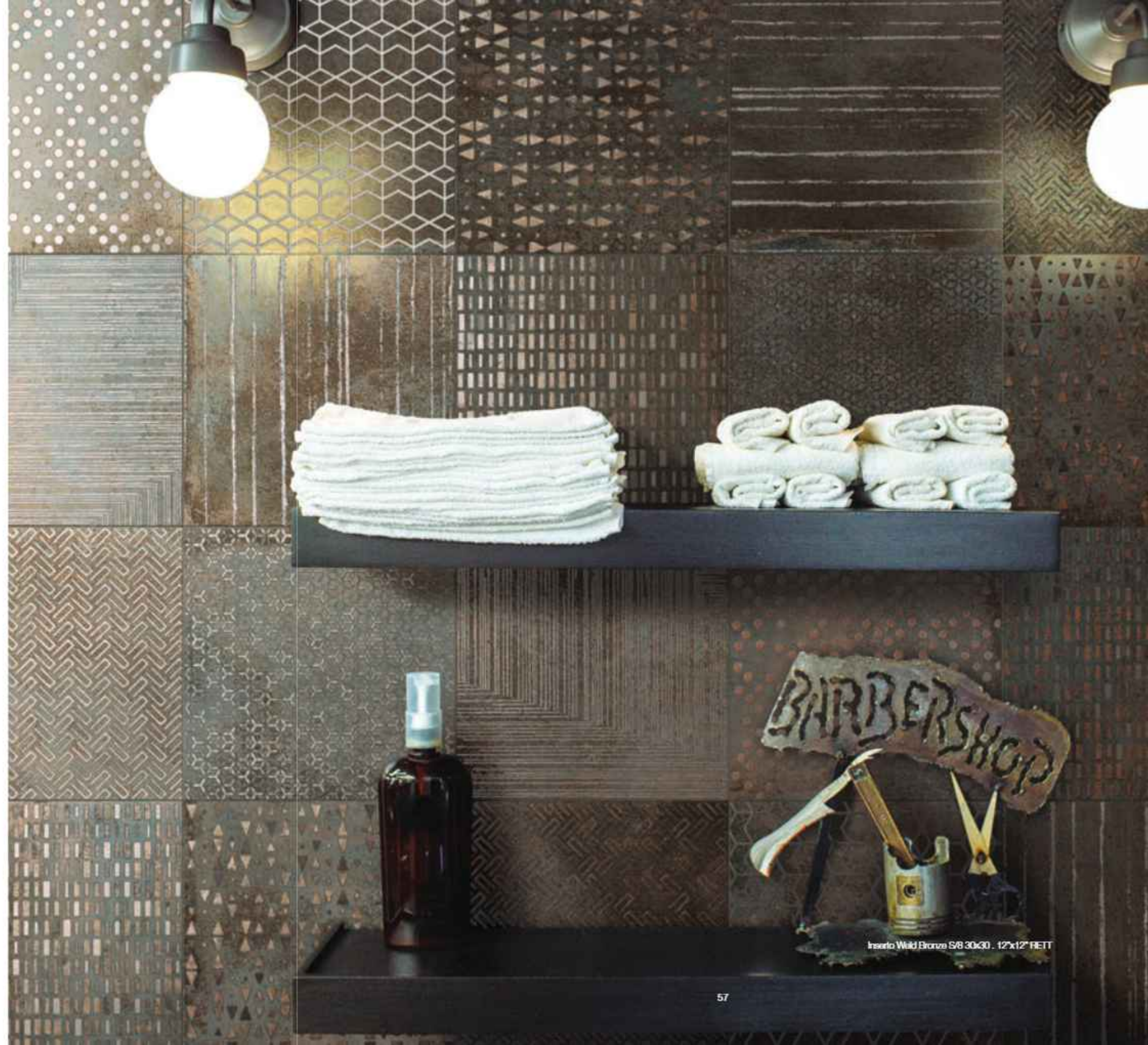

Inserto Weld Bronze S/8 30x30 - 12"x12" RETT

GRES PORCELLANATO SMALTATO COLORATO IN MASSA - ISO 13006 Bia GL
GLAZED PORCELAIN STONWARE WITH COLOURED BODY - GRES CERAME EMAILLE COLORE DANS LA MASSE
GLASIERTES FEINSTEINZEUG IN DER MASSE GEFÄRBT - ГЛАЗУРОВАНИЙ КЕРАМОГРАНИТ, ОКРАШЕННЫЙ ПО ВСЕЙ ТОЛЩИНЕ

	Aspetto superficiale Surface appearance Aspett superficial Oberflächenbeschaffenheit Вид поверхности	± 0,5%	Conforme Complies Conforme Konform Совпадает		
	Lunghezza e larghezza Length and width Longueur et largeur Länge und Breite Длина и ширина	Deviazione valore medio % rispetto a dimensione di fabbricazione. Deviation of the average size for each tile from the work size (%). Écart dimensionnel moyen en % par rapport aux dimensions de fabrication. Abweichung des Durchschnittswertes in % hinsichtlich der Produktionsgröße. Отклонение среднего значения, % от размера номинального размера > 410 cm² +/- 0,5% - < 410 cm² +/- 0,75%	± 0,5% ± 2 mm		
	Rettifichità degli spigoli Squareness of corners Rectitude des angles Kantengradigkeit Прямизна углов среза	Deviazione valore medio % rispetto a dimensione di fabbricazione. Deviation of the average size for each tile from the average size of the 10 test specimens (%). Écart de valeur moyenne relatif en % en rapport à la valeur moyenne de 10 échantillons tests. Abweichung des Durchschnittswertes der einzelnen Fliesen in % hinsichtlich des Durchschnittswertes 10 getesteter Muster. Отклонение среднего значения отдельных элементов группы, максимум 10 измеренных элементов +/- 0,5%	± 0,5% ± 2 mm		
	Sprezzatura / Bis latera / Гранича / Spalte / Kompas Flatness Planéité Spalten Kanten Прямизна	± 1-2%	± 1% ± 0,5 mm		
	Ortogonalità Squareness Orthogonalité Rechtwinkligkeit Ортогональность	± 1-0,5%	± 0,5% ± 1,5 mm		
	Assorbimento d'acqua Water absorption Absorption d'eau Wasseraufnahme Впитываемость	± 0,5% GRUPPO Bia GL	E ± 0,5%		
	Resistenza alla superficie (scala MOHS) Scratch hardness (MOHS scale) Dureté de la surface (échelle MOHS) Oberflächenhärte (MOHS skala) Устойчивость к царапинам (шкала Мооса)	EN 104	> 6		
	Resistenza a flessione e forza di rottura Moduli of rupture and breaking strength résistance à la flexion et force de rupture Biegefestigkeit und Bruchkraft Устойчивость к изгибу и сила разрыва	5 x 1500 N R ± 35 N/mm²	5 x 1500 N R ± 35 N/mm²		
	Resistenza alla abrasione della superficie di piastrelle smaltate Resistance to surface abrasion of glazed tiles Résistance à l'abrasion de la surface des carreaux émaillés Widerstand gegen Abrieb der Oberfläche des glasierten Fliesen Сопротивление истиранию поверхности глазурированного покрытия	Come dichiarato dal produttore See manufacturer's declaration Selon déclaration du fabricant Entsprechend der Herstellerangabe Как указано производителем	Gruppo / Fermi / Classe # Classe 3 Class 1 Class 3 Gruppo 1 Gruppo 3 Kaucz 1 Kaucz 3		
	Coefficiente di dilatazione termica lineare Linear thermal expansion coefficient Coefficient thermique linéaire Lineare Wärmeausdehnungskoeffizient Коэффициент линейного температурного расширения	Come dichiarato dal produttore See manufacturer's declaration Selon déclaration du fabricant Entsprechend der Herstellerangabe Как указано производителем	Metodo disponibile Method available Méthode disponible Verfügbares Verfahren Доступный способ измерения		
	Resistenza allo shock termico Thermal shock resistance Résistance au choc thermique Temperaturstoßbeständigkeit Сопротивление тепловому шоку	Nessun campione deve presentare alterazioni No sample must show visible alteration Aucun échantillon ne doit présenter d'altération Kein Muster darf sichtbaren Veränderungen zeigen Ни какой образец не должен показывать изменения	Resistente Resistant Résistant Widerstandsfähig Устойчивый		
	Resistenza al gelo Frost resistance Résistance au gel Frostbeständigkeit Устойчивость к морозу	Non devono presentare difetti visibili No sample must show visible defect Aucun échantillon ne doit présenter de défaut Muster dürfen keine sichtbaren Schäden zeigen Не должны демонстрировать никаких дефектов	Ingeltes Frost proof Ingeltes Frosttauglich Морозостойкий		
	Resistenza all'attacco chimico (norma EN 12002) Resistance to attack of chemical agents Résistance à l'attaque chimique (norme EN 12002) Schutz vor Lagerbestandsänderungen (norme EN 12002) Сопротивление химическим воздействиям	Nessun campione deve presentare alterazioni No sample must show visible alteration Aucun échantillon ne doit présenter d'altération Muster dürfen keine sichtbaren Veränderungen zeigen Ни какой образец не должен показывать изменения	Classe # A/IIA-IA Class A/IIA-IA Classe A/IIA-IA Gruppo 1 A/IIA-IA Kaucz A/IIA-IA		
	Resistenza alle macchie di piastrelle smaltate Resistance to stains of glazed tiles Résistance aux taches des carreaux émaillés Widerstand gegen Fleckbildung der glasierten Fliesen Сопротивление образованию пятен и загрязнений глазури	Nessun campione deve presentare alterazioni No sample must show visible alteration Aucun échantillon ne doit présenter d'altération Muster dürfen keine sichtbaren Veränderungen zeigen Ни какой образец не должен показывать изменения	Classe 3 Class 3 Classe 3 Gruppo 3 Kaucz 3		
	Resistenza alla sciolinita, Coefficiente di attrito medio Slip resistance, Average coefficient of friction Résistance aux glissements, Coefficient de frottement moyen Rutschbeständigkeit, Mittlere Reibwertigkeit Сопротивление скольжению, Средний коэффициент трения	B.C.R.A.	M ± 0,10		
	Resistenza alla sciolinita, Coefficiente di attrito medio Slip resistance, Average coefficient of friction Résistance aux glissements, Coefficient de frottement moyen Rutschbeständigkeit, Mittlere Reibwertigkeit Сопротивление скольжению, Средний коэффициент трения	DIN 51130	B10	B11	
		DIN 51047	B10 Classe B Class B Groupe B Kaucz B	B11 Classe B Class B Groupe B Kaucz B	
		DCOF Acu Test	M ± 0,10		

imballaggi
 Packing
 Emballage
 Verpackung
 Упаковка

	PCS/BOX	SOM/BOX	KGS/BOX	BOXES/PALLET	SOM/PALLET	KGS/PALLET
80x180 - 32"x17" RETT	1	1,44	29,30	36	51,84	1.100
120x120 - 48"x48" RETT	1	1,44	32,00	40	57,60	1.326
100x100 - 40"x40" RETT	1	1,00	20,65	42	42,00	900
100x100 - 40"x40" INSERTO SCHIACH RETT	1	1,00	20,65	42	42,00	BSC
50x100 - 20"x40" RETT	2	1,00	20,65	42	42,00	BSC
60x120 - 24"x48" RETT	2	1,44	32,00	30	43,20	B/B
30x120 - 12"x48" INSERTO SCHIACH RETT	4	1,44	32,00	24	34,56	1.168
60x60 - 24"x24" RETT	3	1,08	24,00	40	43,20	976
30x60 - 12"x24" RETT	6	1,08	24,00	40	43,20	976
100x100 - 40"x40" 19mm	1	1,00	42,50	21	21,00	926
60x120 - 24"x48" 19mm	2	0,72	30,00	36	25,92	1.118



Posa consigliata con una sfalsatura tra ciascun listello non superiore al 25% della lunghezza.
 When laying, you are recommended not to stagger the strips by more than 25% of the length.
 Pose conseillée avec un décalage entre chaque listel non supérieur au 25% de la longueur.
 Wir empfehlen eine Verlegung im Vertikalverband.
 Рекомендуется укладка с разномом элементов друг относительно друга, не превышающим 25% длины элемента.



Per i grandi formati è consigliata la posa con l'utilizzo di distanziatori livellanti, tipo Levelling System di Raimondi.
 We suggest to lay large sizes with "levelling spaces" like the Raimondi's Levelling System.
 Pour les grands formats, nous conseillons croissillons nivélants, type Levelling System de l'usine Raimondi.
 Wir empfehlen für die Verlegung der grossen Formate die Benutzung von Abstellvorrichtungssysteme, wie z.B. Raimondi Levelling System.
 Для укладки больших форматов советуем использовать распорку выравнивающую деталей типа Levelling System di Raimondi.

NOTE TECNICHE - TECHNICAL NOTES - NOTES TECHNIQUES - TECHNISCHE ANMERKUNGEN - ТЕХНИЧЕСКИЕ ЗАМЕЧАНИЯ
Tutti i formati sono nominali. Cercom Ceramiche si riserva la facoltà di modificare in qualunque momento le informazioni e le caratteristiche illustrate nel presente catalogo, che non sono comunque da ritenersi legalmente vincolanti. I colori e le caratteristiche estetiche dei prodotti sono quanto più possibile vicini a quelli reali, nei limiti consentiti dai processi di stampa.
All sizes are nominal. Cercom Ceramiche reserves the right to modify the information and the characteristics illustrated in this catalogue (which are in any case not legally binding at any moment). The colours and appearance features of the products are as close as possible to reality, within the limitation of the printing process.
Tous les formats sont nominaux. Cercom Ceramiche se réserve la faculté de modifier à tout moment les informations et les caractéristiques figurant dans le présent catalogue, lesquelles n'étant pas par le fabricant au plan légal. Les couleurs et les caractéristiques esthétiques sont fidèles aux couleurs et caractéristiques réelles dans les limites des procédés d'impression.
Alle Formate sind Nennwerte. Die Firma Cercom Ceramiche behält sich vor, die in diesem Katalog enthaltenen Informationen und Eigenschaften jederzeit zu ändern; sie gelten auf keinen Fall als gesetzlich bindend. Die Farben und ästhetischen Eigenschaften der Produkte können innerhalb der Möglichkeiten der Druckverfahren den tatsächlichen Eigenschaften so weit wie möglich nahe.
Все форматы являются номинальными. Cercom Ceramiche оставляет за собой возможность в любой момент изменить в любой момент данные и характеристики, приведенные в настоящем каталоге, которые в любом случае не считаются юридически обязательными. Цвета и эстетические характеристики изделий приближаются к реальности в пределах, допускаемых производственными процессами.

CONSIGLI PER LA POSA - LAYING SUGGESTIONS - CONSEILS POUR LA POSE - VERLEGEHINWEISE - РЕКОМЕНДАЦИИ ПО УКЛАДКЕ
Stendere a terra alcuni metri (almeno 3 mc) per controllare l'effetto d'insieme. Posare il materiale attingendo da più scatole controllandone accuratamente colore, tonalità e scelta. • Nella posa è consigliabile lasciare una fuga di 2 mm tra le piastrelle utilizzando stacco in leno. • La posa modulare è consigliata con una fuga di almeno 2 mm. • È comunque compito del progettista stabilire, in funzione della struttura e della destinazione d'uso del piano di calpestio, il corretto modo di applicazione delle piastrelle.
Lay some pieces of product (at least 3 sqm) to check the overall effect. Lay the material taking it from several boxes and carefully check its size accuracy, shade and material sorting. • In the lay out it advisable to leave at least 2 mm joint between each tile and fill with grout of the same colour as the tile. • We recommend modular laying with a 2 mm +/- joint. • However, the designer has to establish the correct way of application of the tiles depending on the structure and the intended utilization of the floor.
Appuyer sur le sol quelques pieds (au moins 2 mc) pour apprécier l'effet global. Prendre le matériel en utilisant un matériel de même ton. • La pose modulaire est conseillée avec un joint de 2 mm. • D'ailleurs c'est le concepteur qui doit établir, sur la base de la structure et de la destination d'emploi du plan de pavément, le procédé d'application correct des carreaux.
Eine Quadratmeter (min. 2 qm) auf dem Boden legen, um die Gesamtwirkung nachzuprüfen. Wir empfehlen Fliesen aus mehreren Kartons zu verlegen, nach einer sorgfältigen Prüfung des Kartons, des Farbtons und der Sortierung. • Die Fuge zwischen den Fliesen sind ein weites oder graue NS-Empfehlung. • Die Modulverlegung wird mit einer Mindestfuge von 2 mm empfohlen. Es ist auf jeden Fall Aufgabe des Planers, nach der Struktur und dem Verwendungszweck der Rüttfläche, die richtige Verlegung der Fliesen zu bestimmen.
Разложить материал на полу для проверки общего эффекта. Укладывать материал, периодически доставляя материал из разных коробов, контролируя цвет, тональность и сорт. • При укладке рекомендуется оставить между плитками зазор в 2 мм, используя подложку по тону затирки. • Модульную укладку рекомендуется выполнять со швом не менее 2 мм. • В любом случае инженер должен определить, в зависимости от структуры назначения, правильный способ укладки плитки.



© Copyright 2019 Gruppo Romani S.p.A.

Gruppo Romani S.p.A. Industrie Ceramiche
www.grupporomanispa.com





DAL 1975

CERCOM CERAMICHE

www.cercomceramiche.it

Via A. Volta 23/25 - 42013 Casalgrande (RE) Italy
Tel. +39-0522-998411/911
Fax Italy +39-0522-998910
Fax Export +39-0522-996218

